

BZ-Zyklon

Flüssigkeitsabscheider
Separator for separation of liquids

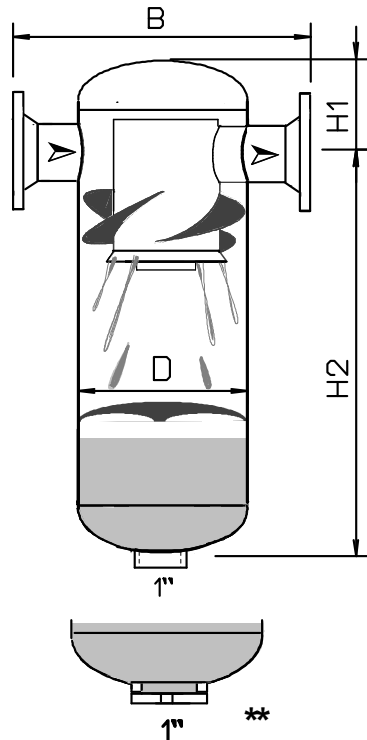

BZ 15 – 250 – 13barü/200°C

Flanschanschluß

BZ 15 – 250 – 13barg/200°C
flange connection

Material:

Stahl geschweißt, außen grundiert
Steel welding design, outside priming coat

Anschlüsse: Flansche nach EN 1092-1
connection: flanges acc. EN 1092-1

Abnahme: gem. DGRL 2014/68 + AD2000
Inspection: acc. PED 2014/68 + AD2000

Designtemperatur: -10 / +200 °C
Design temperature:

** Inspektionsöffnung ab BZ125 / inspection hole from size BZ125 - DN 125

Type BZ	DN	D Ø	H1	H2	B	M	barg	G-Ltr.	S - Ltr.	kg
15	15	63,5	90	360	200	½"	13	1,1	0,4	4,1
20	20	63,5	90	360	210	½"	13	1,1	0,4	4,9
25	25	101,6	100	360	240	1"	13	3,2	0,9	8,1
32	32	101,6	100	450	260	1"	13	3,9	1,7	10,3
40	40	127	110	450	340	1"	13	6,0	2,3	13
50	50	152,4	130	450	360	1"	13	8,9	3,0	19
65	65	177,8	140	480	400	1"	13	13	3,4	22
80	80	219,1	170	480	460	1"	13	22	3,3	28
100	100	267	190	610	520	1"	13	40	8,8	44
125	125	323,9	230	710	610	1"	13	71	11	74
150	150	368	240	810	700	1"	13	103	16	104
175	200	419	280	960	860	1"	13	158	26	145
200	200	500	290	980	900	1"	13	228	35	165
225	250	550	330	1210	950	1"	13	337	65	245
250	250	600	355	1300	990	1"	13	433	80	275

G-Ltr.: Gesamthalt – volume / S-Ltr.: Sammelraum – collecting room
Sonderausführungen auf Anfrage / Special Version on request



Haub + Schöllnhammer Apparatebau GmbH

Untere Industriestr. 55 * 57250 Netphen

Phone +49 (0) 271 222963-0 * Fax +49 (0) 271 222963-30 * www.haub-schoellnhammer.de * info@haub-schoellnhammer.de